

THE
BEST.

kitagawa[®]
NORTHTECH

The Best Workholding.

PRECISION NC TOOLING SYSTEMS

CATALOG 116-2

DETA-1 COLLET CHUCKS
CTA/CTH COLLET CHUCKS
SLIMLINE SHRINK-FIT HOLDERS
& ADAPTERS

 **MST**



Kitagawa Northtech, Inc.

301 Commerce Dr. Schaumburg, IL 60173

• 800.222.4138 • www.kitagawa-usa.com • info@kitagawa-usa.com



DETa-1 COLLET CHUCKS - A TYPE PAGE 4



SLIMLINE - HSK PAGE 15



DETa-1 COLLET CHUCKS - B & E TYPE PAGE 5



SLIMLINE - HEATERS PAGE 21



CTA-CTH COLLET CHUCKS PAGE 6



SLIMLINE - MONO & CURVE PAGE 22



SLIMLINE - MASTER HOLDERS PAGE 10

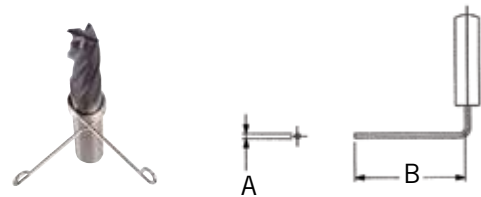

SLIMLINE - ACCESSORIES PAGE 23



SLIMLINE - REGULAR & SLIM PAGE 11



SLIMLINE - FLUSH & STRAIGHT PAGE 14

Web: kitagawa-usa.com

Email: info@kitagawa-usa.com

Call: 1.800.222.4138

MST DETa-1 COLLET CHUCKS - THE ALL-IN-ONE COLLET CHUCKS FOR DRILLING, END MILLING, TAPPING, & REAMING



PATENTED

- MOST PRECISE COLLET CHUCK - .0002" T.I.R. AT LENGTH OF 4X DIA.
- WIDE COLLAPSE RANGE UP TO .080" PER COLLET.
- INCREASE CARBIDE TOOL LIFE: AN AVERAGE OF 200% TO 300%
- PERFECT SOLUTION TO REAMING PROBLEMS (i.e. OVERSIZED, OUT-OF-ROUND, NOT STRAIGHT, POOR FINISH, ETC.)
- DETa-1 CAN PROVIDE COOLANT THRU THE MACHINE SPINDLE, PRESSURISED UP TO 1,000 PSI ON E TYPE MODELS.

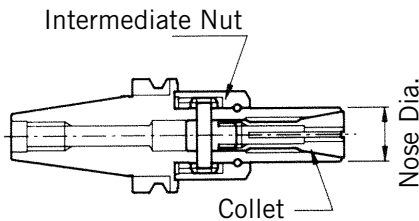

A TYPE NUT WITH DRAW NUT

- The collet is tightened with intermediate nut, which is set back for better clearance.
- Ideal for drilling, reaming and tapping
- Minimum nose diameter:

Model	A070	.79
Model	A120	1.18

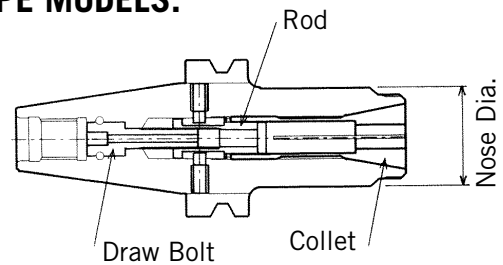

B TYPE AND E TYPE WITH DRAW BOLT

- The collet is tightened with draw bolt.
- The nut is eliminated from the nose, resulting in high RPM operation.
- Ideal for milling with E Type
- Minimum nose diameter:

Model	B070	.83
Model	B120	1.18
Model	E070	1.14
Model	E120	1.58

MST DETa-1 COLLET CHUCKS - A TYPE

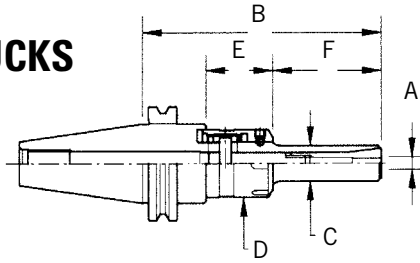

TAPER	ORDER NO.	RANGE A	COLLET	B	C	D	E	F
CAT40	140-A070-4	.039 - .276	#070	4.02	.79	1.50	1.46	1.18
	140-A070-5			5.20				2.36
	140-A120-5	.098 - .512	#120	5.12	1.18	1.77	1.67	2.07
	140-A120-6			6.00				2.95
CAT50	150-A070-4	.039 - .276	#070	4.02	.79	1.50	1.46	1.18
	150-A070-5			5.20				2.36
	150-A070-6			6.00				2.36
	150-A070-8			8.00				2.36
	150-A120-5	.098 - .512	#120	5.12	1.18	1.77	1.57	2.07
	150-A120-6			6.00				2.95
	150-A120-8			8.00				2.95
BT30	230-A070-4	.039 - .276	#070	3.54	.79	1.50	1.67	1.18
	230-A070-5			4.72				2.36
	230-A120-5	.098 - .512	#120	4.72	1.18	1.77	1.69	2.07
BT40	240-A070-4	.039 - .276	#070	4.13	.79	1.50	1.46	1.50
	240-A070-5			5.31				2.36
	240-A120-5	.098 - .512	#120	4.72	1.18	1.77	1.57	2.07
	240-A120-6			5.91				2.95

Note: Purchase wrenches (p23) and collets (p4) separately.

Note: A-Type also available in HSK63A and HSK100A shank configurations.

COLLETS FOR MST DETa-1 COLLET CHUCKS



CHUCK SIZE	ORDER NO.	RANGE	CHUCK SIZE	ORDER NO.	RANGE
#070	0-070-015	.039 - .059	#120	0-120-040	.098 - .157
	0-070-020	.059 - .079		0-120-060	.157 - .236
	0-070-025	.079 - .098		0-120-080	.236 - .315
	0-070-030	.098 - .118		0-120-100	.315 - .394
	0-070-040	.118 - .157		0-120-120	.394 - .472
	0-070-050	.157 - .197		0-120-130	.433 - .512
	0-070-060	.197 - .236			
	0-070-070	.236 - .276			

MST DETa-1 COLLET CHUCKS - B & E TYPES

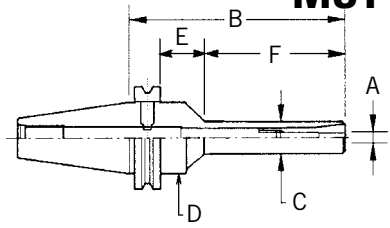

B TYPE CAT & BT

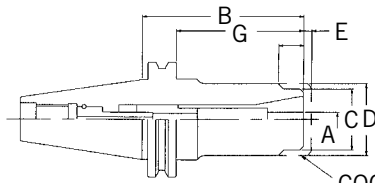

E TYPE CAT ONLY

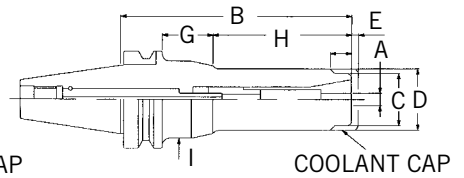

E TYPE BT ONLY

B-TYPE COLLET CHUCKS

TAPER	ORDER NO.	RANGE A	COLLET	B	C	D	E	F
CAT40	140-B070-4	.039 - .276	#070	4.13	.83	1.75	.63	2.76
	140-B070-5			5.31				2.95
	140-B120-5	.098 - .512	#120	4.72	1.18	2.75	.63	3.35
	140-B120-6			5.91				4.13
CAT50	150-B070-5	.039 - .276	#70	5.31	.83	1.75	1.61	2.95
	150-B070-8			7.68				2.95
	150-B120-5	.098 - .512	#120	5.31	1.18	2.75	.63	3.94
	150-B120-6			6.50				4.13
	150-B120-8			7.68				4.13
BT30	230-B070-3	.039 - .276	#070	2.95	.83	—	—	2.08
	230-B120-3*	.098 - .512	#120	2.95	1.18	—	—	2.08
BT40	240-B070-4	.039 - .276	#070	4.13	.83	—	—	3.07
	240-B070-5			5.31		1.18	1.30	2.95
	240-B120-5	.098 - .512	#120	4.72	1.18	—	—	3.66
	240-B120-6			5.91		1.57	.71	4.13

E-TYPE COLLET CHUCKS

TAPER	ORDER NO.	RANGE A	COLLET	B	C	D	E	F	G
CAT40	140-E070-4	.039-.276	#070	3.54	.94	1.14	.12	.45	2.80
	140-E070-5			4.72					3.98
	140-E120-4	.098-.512	#120	3.54	1.34	1.58	.18	.55	2.80
	140-E120-6			5.91					5.16
CAT50	150-E120-4	.098-.512	#120	4.13	1.34	1.58	.18	.55	3.39
	150-E120-6			6.50					5.75

TAPER	ORDER NO.	RANGE A	COLLET	B	C	D	E	F	G	H	I
BT40	240-E070-4	.039-.276	#070	3.54	.94	1.14	.12	.45	—	2.48	—
	240-E070-5			4.72					.91	2.76	1.57
	240-E120-4	.098-.512	#120	3.54	1.34	1.58	.18	.55	—	2.48	—
	240-E120-6			5.91					—	4.84	—

Note: Purchase collets (p4) and wrenches (p23) separately.

Note: * requires a special retention knob. Specify machine manufacturer's name and model number for a quotation.

Note: E-Type is recommended for milling application and available in CAT40, CAT50, BT40, HSK63A, and HSK100A shank configurations.

MST CTA/CTH ULTRA-PRECISION COLLET CHUCKS FOR HIGH SPEED, HIGH FEED-RATE APPLICATIONS



- THE MOST ACCURATE COLLET CHUCKS IN THE INDUSTRY .0002" T.I.R. AT LENGTH OF 4X DIA. FOR P-GRADE COLLET
- CONSTANT BALANCE™ DESIGN FOR HIGH-RPM APPLICATIONS
- ADVANCED THRU BODY COOLANT, PRESSURIZED UP TO 1,000 PSI
- ENGINEERED FOR ULTIMATE RIGIDITY
- IDEAL 6° COLLET TAPER ENSURES SUPERB PERFORMANCE

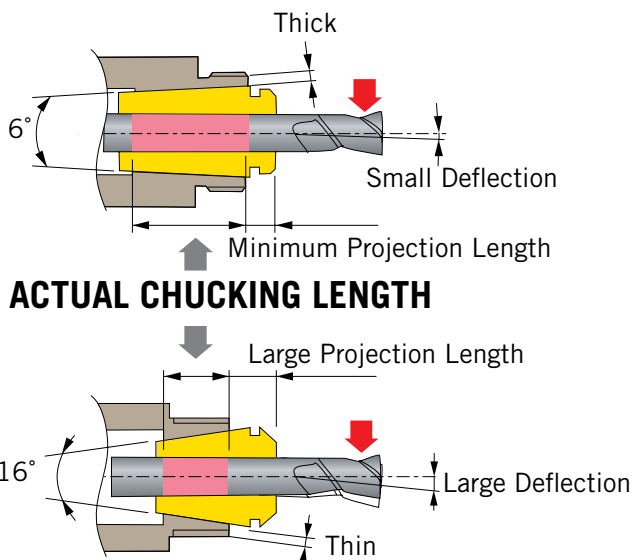

COMPARISON BETWEEN 6° & 16° TAPER COLLETS

A 6° taper angle secures a longer chucking length of cutting tools and creates a higher wedge effect, providing a min. deflection of cutting tools. With a 6° taper angle, the minimum projection length assures optimum cutting performance, because most of cutting forces are on the sturdy CTA/CTH collet chuck body.

A 16° taper system provides a larger chucking range; however, the cutting force is exerted on the collet nut due to larger collet projection length, resulting in chattering or accidental ejection of cutting tools.

MST CTA/CTH ULTRA-PRECISION COLLET CHUCKS AND COLLETS

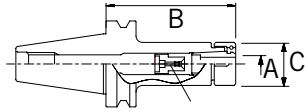

COOLANT SCREWS (Optional accessory)

TAPER	ORDER NO.	RANGE A	B	C	APPLICABLE CUTTER SHANK DIA.	COOLANT SCREW
CAT40	140-113-2	.125-.375	2.36	1.42	.16 - .375	0-1402
	140-113-4		3.54			
	140-113-5		4.72			
	140-116-3	.250-.750	2.95	1.97	.39-.75 .24-.47	0-2402, 0-2403
	140-116-5	.250-.750	5.31	1.97		0-2402, 0-2403
	140-118-3*	.250-1.000	2.95	2.44		0-2402, 0-2403
CAT50	150-116-4	.250-.750	4.13	1.97	.39-.75 .24-.47	0-2402, 0-2403
	150-116-7	.250-.750	6.50	1.97		0-2402, 0-2403
	150-118-4	.250-1.000	2.44	2.44		0-2402, 0-2403
BT30	230-113-2	.125 - .375	1.77	1.42	.16 - .375	0-1402
	230-116-2	.250 - .750	2.36	1.97	—	—
BT40	240-113-2	.125 - .375	2.36	1.42	.16 - .375	0-1402
	240-113-3		3.54			
	240-113-6		5.91			
	240-113-8		8.27			
	240-116-2	.250 - .750	2.36	1.97	.39 - .75 .24 - .47	0-2402, 0-2403
	240-116-4		3.54			
	240-116-6		5.91			
	240-116-8		8.27			
	240-118-3	.250 - 1.000	2.95	2.44	.47 - 1.00	0-2802
	240-118-4		4.13	2.44		

Note: Purchase collets (p7), wrenches (p23), and coolant screws. Sukima nut is required for cooland around tool.

Note: * means not a standard CAT configuration. Make sure ATC of your machine accepts this configuration.

Note: Also available in various HSK Shank configurations.

COLLETS FOR CTA/CTH



COLLET SIZE	ORDER NO.	COLLET CHUCK	COLLET SIZE	ORDER NO.	COLLET CHUCK
1/8	0-113-008	#113	5/8	0-116-040	#116
3/16	0-113-012*		3/4	0-116-048	
1/4	0-113-016		1/4	0-118-016	#118
5/16	0-113-020*		5/16	0-118-020*	
3/8	0-113-024	3/8	0-118-024		
1/4	0-116-016	#116	7/16	0-118-028*	
5/16	0-116-020*		1/2	0-118-032	
3/8	0-116-024		5/8	0-118-040	
7/16	0-116-028*		3/4	0-118-048	
1/2	0-116-032		1	0-118-064	

Note: Collet collapsibility – .008"

Note: * means the size not in stock.

Note: Metric size available upon request.

Please consult Kitagawa NorthTech for details.

MST SLIMLINE - SHRINK-FIT CHUCKING SYSTEM



PATENTED

- SUPERB ACCURACY WITHIN .0002" T.I.R.
- INCREASE CARBIDE TOOL LIFE UP TO 300%
- INTERFERENCE-FREE OPERATION WITH 3° TAPERED BODY AND MINIMUM WALL THICKNESS OF .059"
- OPTIMUM BALANCED DESIGN FOR HIGH SPEED OPERATION OVER 40,000 RPM
- VARIETY OF PROJECTION LENGTH
- ADVANCED COOLANT THRU BODY DESIGN

Slimline is a remarkable compact shrink-fit system that uses a special stainless steel alloy that has 60% higher coefficient thermal expansion than H13, a very common shrink-fit material. With the virtue of this special stainless steel alloy, the heating of the adapter takes place within the temperature range, not affecting its physical properties. As the result, the system will maintain its original design level of performance.

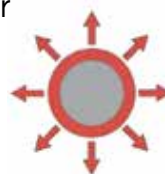
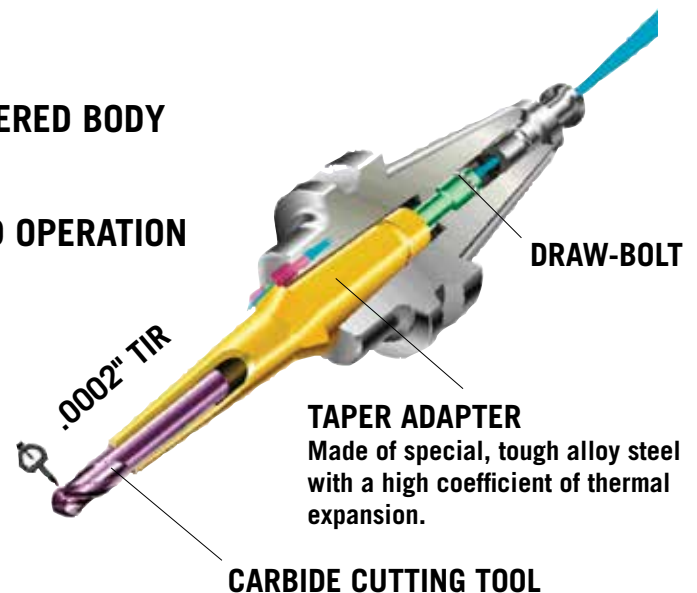

Heating
750 °F or 400 °C (open)

SHRINK-FIT GRIPPING

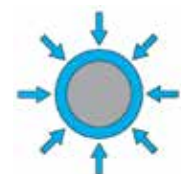

Cooling (close)

MST SLIMLINE SHRINK-FIT CHUCKING SYSTEM

MASTER HOLDERS



TAPER ADAPTERS



REGULAR TYPE

- Recommended for general operation.
- Maximum rigidity for heavy radial load.
- Wall thickness: .088" - .157"



SLIM TYPE

- Recommended for semi-finish and finish operations.
- Wall thickness: .059"



FLUSH TYPE

- Coolant-thru holes at the nose of adapters for machining enhancement.

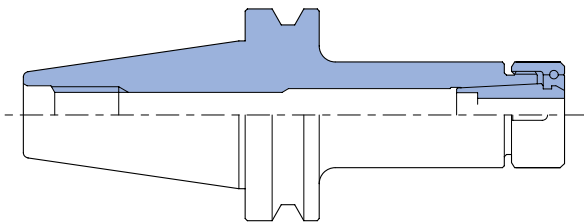

CTA COLLET CHUCK

STRAIGHT ADAPTERS



- Available in Regular and Slim types
- Available in Solid Carbide shanks for vibration-free machining with max. rigidity
- Recommended to use with CTA/CTH Collet Chucks (p82) for optimum accuracy.

CUSTOM MODIFICATION

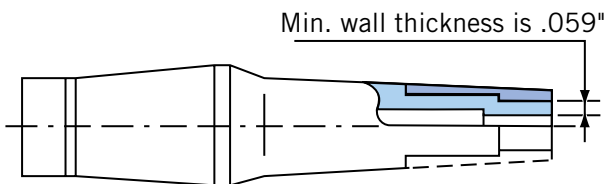

The Slimline's design allows machining in very tight spaces. Nonetheless, users with a need for an even slimmer toolholder can turn down the outside diameter. To assist in modifications, a complete set of Slimline CAD drawings is available.



MST SLIMLINE SHRINK-FIT CHUCKING SYSTEM MASTER HOLDERS

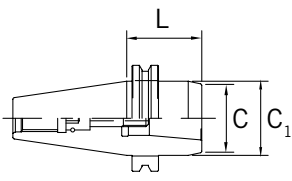

FIG. 1

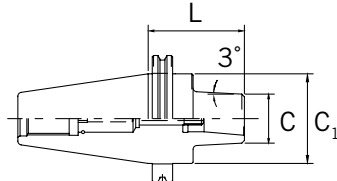

FIG. 2

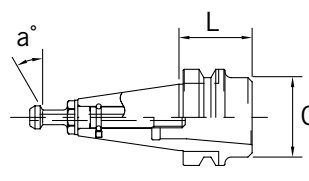

FIG. 3

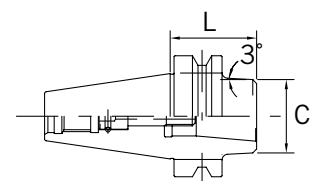

FIG. 4

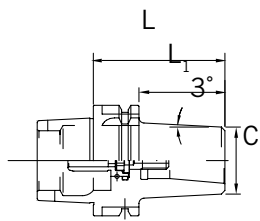

FIG. 5

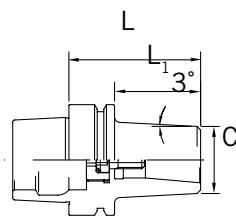

FIG. 6

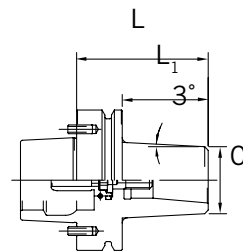

FIG. 7

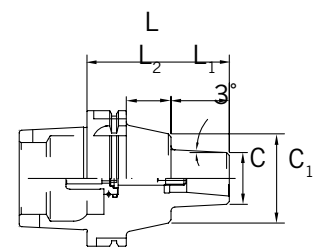

FIG. 8

TAPER	ORDER NO.	L	C	C ₁	WT (LB.)	FIG.
CAT40	140-510-2	1.77	1.61	1.75	2.4	1
	140-510-3	2.95	1.50	1.75	2.9	1
CAT50	150-510-3	2.95	1.50	2.75	7.3	2
	150-510-9	8.86			12.6	
	150-510-12	12.40			17.6	

TAPER	ORDER NO.	RET KNOB	a	L	C	WT (LB.)	FIG.
BT30	230-510-1A	MAS-I	45°	1.38	1.50	1.3	3
	230-510-1B	MAS-II	30°				
BT40	240-510-2	—	—	1.77	—	2.4	4

Note: Purchase Slimline adapters and wrench, W-135 (p23) for 240-510-2, separately.

Note: 230-510-1A comes with a special retention knob/draw bolt in MAS-I (2300-10) configuration.

230-510-1B comes with a special retention knob/draw bolt in MAS-II (2300-20) configuration.

TAPER	ORDER NO.	L	L ₁	L ₂	C	C ₁	WT. (LB.)	FIG.
HSK E50	050E-510-3	2.95	1.93	—	1.50	—	1.8	6
HSK A63	063-510-3	2.95	1.93				2.2	5
HSK A63	063-510-5	5.31	4.29				3.7	6
HSK E63	063E-510-3	2.95	1.93				2.2	6
HSK F63	063F-510-3						2.2	6
HSK F80	080FPD-510-3						2.5	7
HSK A100	100-510-4	4.13	1.69	1.30	—	2.56	7.5	8

Note: Purchase Slimline adapters and wrenches, W-135 (p23), separately.

Note: Coolant duct is furnished with 063-510-3 and 100-510-4 only.

Note: 080FPD-510-3 is for Makino MAG machines only.

MST SLIMLINE SHRINK-TAPER ADAPTERS - INCH, REGULAR TYPE

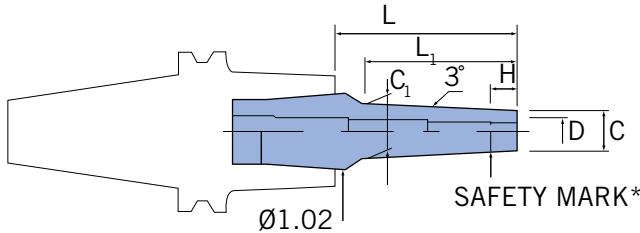

- **GUARANTEED ACCURACIES** At Length of 4X DIA.0002" TIR
- **GROUND CHUCK BODY** FOR PERFECT TOOL BALANCE
- **ADVANCED COOLANT THRU BODY DESIGN**

REGULAR TYPE - INCH

ORDER NO.	D	L	L ₁	C	C ₁	H	MAX INSERTION LENGTH
510-2299-1	.1250	1.38	.87	.36	.45	.39	2.56
510-2299-2		2.17	1.65		.53		3.35
510-2299-3		3.15	2.64		.64		4.33
510-2300-1	.1875	1.38	.87	.42	.51	.59	2.56
510-2300-2		2.17	1.65		.60		3.35
510-2300-3		3.15	2.64		.70		4.33
510-2301-1	.2500	1.38	.87	.49	.58	.71	2.56
510-2301-2		2.17	1.65		.66		3.35
510-2301-3		3.15	2.64		.76		4.33
510-2302-1	.3125	1.38	.87	.55	.64	.98	2.56
510-2302-2		2.17	1.65		.72		3.35
510-2302-3		3.15	2.64		.83		4.33
510-2303-1	.3750	1.38	.87	.61	.70	1.18	2.36
510-2303-2		2.17	1.65		.78		
510-2303-3		3.15	2.64		.89		
510-2304-1	.5000	1.38	.87	.81	.91		
510-2304-2		2.17	1.99		—		
510-2304-3		3.15	—		1.00		

Note: Use with carbide cutting tools only. * means carbide cutting tool shank should be inserted beyond the safety mark for optimum accuracy and rigidity.

Note: Requires a cutter shank tolerance of h6: Ø1/8" - Ø3/16" and h7: Ø1/4" - Ø1/2", per British Standard Limits of Tolerance for selected shafts: BS4500:1969.

MST SLIMLINE SHRINK-TAPER ADAPTERS - INCH, SLIM TYPE

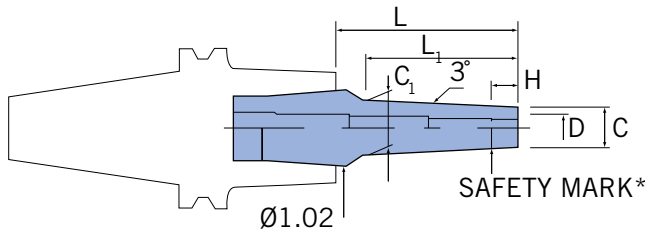

- **GUARANTEED ACCURACIES** At Length of 4X DIA.0002" TIR
- **GROUND CHUCK BODY FOR PERFECT TOOL BALANCE**
- **ADVANCED COOLANT THRU BODY DESIGN**

SLIM TYPE - INCH

ORDER NO.	D	L	L ₁	C	C ₁	H	MAX INSERTION LENGTH
510-3299-1	.1250	1.38	.87	.24	.33	.39	2.56
510-3299-2		2.17	1.65		.41		3.35
510-3299-3		3.15	2.64		.52		4.33
510-3299-4		4.33	3.82		.64		5.51
510-3300-1	.1875	1.38	.87	.31	.04	.59	2.56
510-3300-2		2.17	1.65		.48		3.35
510-3300-3		3.15	2.64		.58		4.33
510-3300-4		4.33	3.82		.71		5.51
510-3301-1	.2500	1.38	.87	.37	.46	.71	2.56
510-3301-2		2.17	1.65		.54		3.35
510-3301-3		3.15	2.64		.64		4.33
510-3301-4		4.33	3.82		.77		5.51
510-3302-1	.3125	1.38	.87	.43	.52	.98	2.56
510-3302-2		2.17	1.65		.60		3.35
510-3302-3		3.15	2.64		.71		4.33
510-3302-4		4.33	3.82		.83		5.51
510-3303-1	.3750	1.38	.87	.49	.58	1.18	2.36
510-3303-2		2.17	1.65		.66		
510-3303-3		3.15	2.64		.77		
510-3303-4		4.33	3.82		.89		
510-3304-1	.5000	1.38	.87	.62	.71	1.18	2.36
510-3304-2		2.17	1.65		.79		
510-3304-3		3.15	2.64		.89		
510-3304-4		4.33	—		—		

Note: Use with carbide cutting tools only. * means carbide cutting tool shank should be inserted beyond the safety mark for optimum accuracy and rigidity.

Note: Requires a cutter shank tolerance of h6: Ø1/8" - Ø3/16" and h7: Ø1/4" - Ø1/2", per British Standard Limits of Tolerance for selected shafts: BS4500:1969.

MST SLIMLINE SHRINK-TAPER ADAPTERS - REGULAR & SLIM TYPE

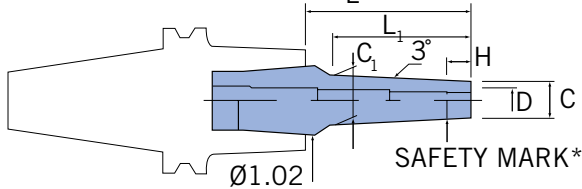

- **GUARANTEED ACCURACIES** At Length of 4X DIA.0002" TIR
- **GROUND CHUCK BODY** FOR PERFECT TOOL BALANCE
- **ADVANCED COOLANT THRU BODY** DESIGN

REGULAR TYPE - METRIC

ORDER NO.	D	L	L	C	C	H	MAX INSERT LENGTH
510-2003-1	3MM	1.38	.87	.30	.39	.38	2.56
510-2003-2		2.17	1.65		.47		3.35
510-2003-3		3.15	2.64		.57		4.33
510-2004-1	4MM	1.38	.87	.39	.48	.46	2.56
510-2004-2		2.17	1.65		.57		3.35
510-2004-3		3.15	2.64		.67		4.33
510-2006-1	6MM	1.38	.87	.47	.56	.70	2.56
510-2006-2		2.17	1.65		.65		3.35
510-2006-3		3.15	2.64		.75		4.33
510-2008-1	8MM	1.38	.87	.55	.64	.98	2.56
510-2008-2		2.17	1.65		.72		3.35
510-2008-3		3.15	2.64		.83		4.33
510-2010-1	10MM	1.38	.87	.63	.72	1.18	2.36
510-2010-2		2.17	1.65		.80		
510-2010-3		3.15	2.64		.91		
510-2012-1	12MM	1.38	.87	.79	.88	1.18	2.36
510-2012-2		2.17	1.65		.96		
510-2012-3		3.15	—		1.00		

SLIM TYPE - METRIC

510-3003-1	3MM	1.38	.87	.24	.33	.38	2.56
510-3003-2		2.17	1.65		.41		3.35
510-3003-3		3.15	2.64		.51		4.33
510-3003-4		4.33	3.82		.64		5.51
510-3004-1	4MM	1.38	.87	.28	.37	.46	2.56
510-3004-2		2.17	1.65		.45		3.35
510-3004-3		3.15	2.64		.55		4.33
510-3004-4		4.33	3.82		.68		5.51
510-3006-1	6MM	1.38	.87	.35	.44	.70	2.56
510-3006-2		2.17	1.65		.53		3.35
510-3006-3		3.15	2.64		.63		4.33
510-3006-4		4.33	3.82		.76		5.51
510-3008-1	8MM	1.38	.87	.43	.52	.98	2.56
510-3008-2		2.17	1.65		.61		3.35
510-3008-3		3.15	2.64		.71		4.33
510-3008-4		4.33	3.82		.83		5.51
510-3010-1	10MM	1.38	.87	.51	.60	1.18	2.36
510-3010-2		2.17	1.65		.69		
510-3010-3		3.15	2.64		.79		
510-3010-4		4.33	3.82		.91		
510-3012-1	12MM	1.38	.87	.59	.68	1.18	2.36
510-3012-2		2.17	1.65		.76		
510-3012-3		3.15	2.64		.87		
510-3012-4		4.33	—		—		

Note: Use with carbide cutting tools only. * means carbide cutting tool shank should be inserted beyond the safety mark for optimum accuracy and rigidity.

Note: Require a cutter shank tolerance of h6: Ø3MM - Ø4MM and h7: Ø6MM - Ø12MM, per British Standard Limits of Tolerance for selected shafts: BS4500:1969.

MST SLIMLINE SHRINK-TAPER ADAPTERS - FLUSH & STRAIGHT TYPES

FLUSH TYPE

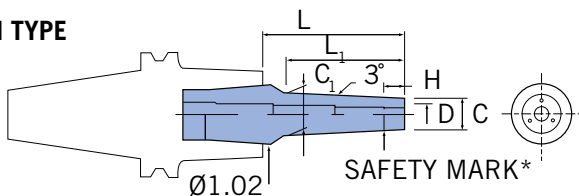

STRAIGHT TYPE

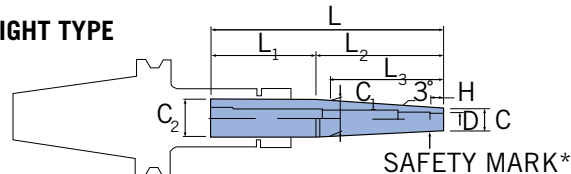

• GUARANTEED ACCURACIES At Length of 4X DIA.0002" TIR

• ADVANCED COOLANT THRU BODY DESIGN

• GROUND CHUCK BODY FOR PERFECT TOOL BALANCE

FLUSH TYPE - INCH

ORDER NO.	D	L	L ₁	C	C ₁	H	MAX INSERT. LENGTH
510-4299-1		1.38	.87		.47		2.56
510-4299-2	.1250	2.17	1.65	.38	.55	.39	3.35
510-4299-3		3.15	2.64		.66		4.33
510-4300-1		1.38	.87		.59		2.56
510-4300-2	.1875	2.17	1.65	.50	.68	.59	3.35
510-4300-3		3.15	2.64		.78		4.33
510-4301-1		1.38	.87		.66		2.56
510-4301-2	.2500	2.17	1.65	.56	.74	.71	3.35
510-4301-3		3.15	2.64		.84		4.33
510-4302-1		1.30	.87		.72		2.56
510-4302-2	.3125	2.17	1.65	.63	.80	.98	3.35
510-4302-3		3.15	2.64		.90		4.33
510-4303-1		1.38	.87		.78		2.56
510-4303-2	.3750	2.17	1.65	.69	.86	1.18	2.36
510-4303-3		3.15	2.64		.97		4.33
510-4304-1		1.38	.87		.91		2.56
510-4304-2	.5000	2.17	1.99	.81	—	1.18	2.36
510-4304-3		3.15	1.80		1.00		4.33

FLUSH TYPE - METRIC

510-4003-1		1.38	.87		.46		2.56
510-4003-2	3MM	2.17	1.65	.37	.55	.38	3.35
510-4003-3		3.15	2.64		.65		4.33
510-4004-1		1.38	.87		.56		2.56
510-4004-2	4MM	2.17	1.65	.47	.65	.46	3.35
510-4004-3		3.15	2.64		.75		4.33
510-4006-1		1.38	.87		.64		2.56
510-4006-2	6MM	2.17	1.65	.55	.72	.70	3.35
510-4006-3		3.15	2.64		.83		4.33
510-4008-1		1.38	.87		.72		2.56
510-4008-2	8MM	2.17	1.65	.63	.80	.98	3.35
510-4008-3		3.15	2.64		.91		4.33
510-4010-1		1.38	.87		.80		2.56
510-4010-2	10MM	2.17	1.65	.71	.88	1.18	2.36
510-4010-3		3.15	—		—		4.33
510-4012-1		1.38	.87		.88		2.56
510-4012-2	12MM	2.17	1.65	.79	.96	1.18	2.36
510-4012-3		3.15	—		—		4.33

STRAIGHT TYPE - INCH

ORDER NO.	D	L	L ₁	L ₂	L ₃	C	C ₁	C ₂	H	MAX INSERT. LENGTH
706-3299-8	.1250	7.87	3.54	4.33	3.82	.24	.64	.750	.38	3.23
706-3301-8	.2500	7.87	3.94	3.94	—	.37	—	.750	.70	3.23
708-3303-9	.3750	9.06	4.72	4.33	3.82	.49	.89	1.00	1.18	2.36

Note: Use with carbide cutting tools only. * means carbide cutting tool shank should be inserted beyond the safety mark for optimum accuracy and rigidity.

Note: Require a cutter shank tolerance of h6: Ø1/8" - Ø3/16" and h7: Ø1/4" - Ø1/2" and h6: Ø3MM - Ø4MM and h7: Ø6MM - Ø12MM, per British Standard Limits of Tolerance for selected shafts: BS4500:1969.

MST SLIMLINE SHRINK-FIT HSK 25E SERIES - REGULAR & SLIM TYPES

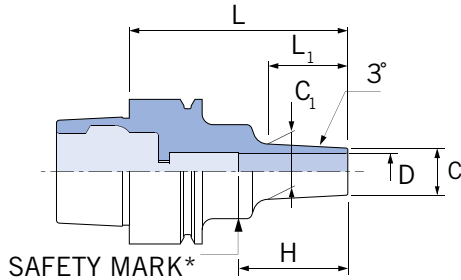

- **GUARANTEED ACCURACIES AT**
Length of 4X DIA.00012" TIR
- **GROUND CHUCK BODY FOR PERFECT**
TOOL BALANCE
- **ADVANCED COOLANT THRU**
BODY DESIGN

REGULAR TYPE - METRIC

TYPE	ORDER NO.	D	L	L ₁	C	C ₁	H	WT (lb.)	MAX INSERT LENGTH
E25	E25-2003-1	3MM	1.38	.67	.30	.37	.35	0.13	1.14
	E25-2004-1	4MM	1.38	.67	.39	.46	.47	0.14	1.14
	E25-2006-1	6MM	1.38	.67	.47	.54	.71	0.15	1.02

SLIM TYPE - METRIC

TYPE	ORDER NO.	D	L	L ₁	C	C ₁	H	WT (lb.)	MAX INSERT LENGTH
E25	E25-3003-1	3MM	1.38	.67	.24	.31	.35	0.13	1.14
	E25-3003-2	3MM	1.97	1.26	.24	.37	.35	0.13	1.73
	E25-3299-1	1/8"	1.38	.67	.24	.31	.35	0.13	1.14
	E25-3299-2	1/8"	1.97	1.26	.24	.38	.35	0.13	1.73
	E25-3004-1	4MM	1.38	.67	.28	.35	.47	0.13	1.14
	E25-3004-2	4MM	1.97	1.26	.28	.41	.47	0.13	1.73
	E25-3005-1	5MM	1.38	.67	.31	.39	.59	0.13	1.02
	E25-3006-1	6MM	1.38	.67	.35	.43	.71	0.11	1.02
	E25-3006-2	6MM	1.97	1.26	.35	.49	.71	0.15	1.54

Note: Use with carbide cutting tools only. Coolant Duct is not furnished.

Note: * means carbide cutting tool shank should be inserted beyond the safety mark for optimum accuracy and rigidity.

Note: Inch size holders are available upon request.

Note: Require a cutter shank tolerance of h6: Ø3MM - Ø5MM and h7: Ø6MM - Ø16MM, per British Standard Limits of Tolerance for selected shafts: BS4500:1969.

MST SLIMLINE SHRINK-FIT HSK 32E SERIES - REGULAR & SLIM TYPES

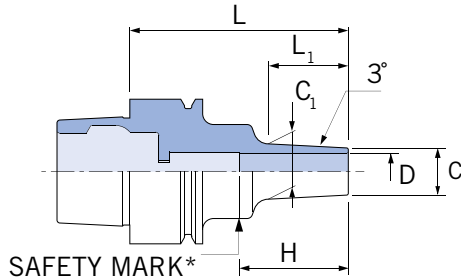

- **GUARANTEED ACCURACIES AT**
Length of 4X DIA.00012" TIR

- **GROUND CHUCK BODY FOR PERFECT**
TOOL BALANCE

- **ADVANCED COOLANT THRU**
BODY DESIGN

REGULAR TYPE - METRIC

TYPE	ORDER NO.	D	L	L ₁	C	C ₁	H	WT (lb.)	MAX INSERT LENGTH
E32	E32-2003-2	3MM	1.97	.87	.30	.39	.35	0.22	1.65
	E32-2003-3		2.76	1.65		.47		0.44	2.44
	E32-2003-4		3.35	1.65		.47		0.44	2.72
	E32-2004-2	4MM	1.97	.87	.39	.48	.47	0.44	1.38
	E32-2004-3		2.76	1.65		.57			2.13
	E32-2004-4		3.35	1.65		.57			2.72
	E32-2006-2	6MM	1.97	.87	.47	.56	.71	0.44	1.38
	E32-2006-3		2.76	1.65		.65			2.13
	E32-2006-4		3.35	1.65		.65			2.72
	E32-2008-2	8MM	1.97	.87	.55	.64	.94	0.44	1.54
	E32-2008-3	8MM	3.35	1.65	.55	.72	.94		2.72
	E32-2010-2	10MM	2.17	.87	.63	.72	1.18		1.73
E32-2012-2	12MM	2.17	.87	.79	.88	1.18	1.73		
E32-2016-2	16MM	2.17	1.38	1.02	N/A	1.26	1.73		

SLIM TYPE - METRIC

TYPE	ORDER NO.	D	L	L ₁	C	C ₁	H	WT (lb.)	MAX INSERT LENGTH
E32	E32-3003-2	3MM	1.97	.87	.24	.33	.35	0.22	1.65
	E32-3003-3		2.76	1.65		.41		0.44	2.44
	E32-3003-4		3.35	1.65		.41		0.44	2.72
	E32-3299-2	1/8"	1.97	.87	.24	.33	.35	0.22	1.65
	E32-3004-2	4MM	1.97	.87	.28	.37	.47	0.22	1.38
	E32-3004-3		2.76	1.65		.45		0.44	2.13
	E32-3004-4		3.35	1.65		.45		0.44	2.72
	E32-3006-3	6MM	2.76	1.65	.35	.53	.71	0.44	2.13

Note: Use with carbide cutting tools only. Coolant Duct is not furnished.

Note: * means carbide cutting tool shank should be inserted beyond the safety mark for optimum accuracy and rigidity.

Note: Inch size holders are available upon request.

Note: Require a cutter shank tolerance of h6: Ø3MM - Ø5MM and h7: Ø6MM - Ø16MM, per British Standard Limits of Tolerance for selected shafts: BS4500:1969.

MST SLIMLINE SHRINK-FIT HSK 40E SERIES - METRIC, REGULAR TYPE

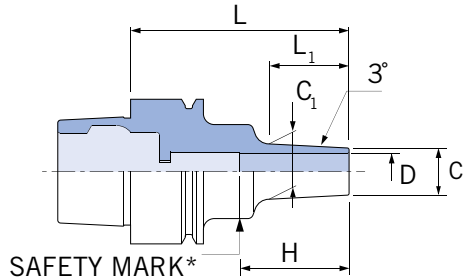

- **GUARANTEED ACCURACIES AT**
Length of 4X DIA.00012" TIR
- **GROUND CHUCK BODY FOR PERFECT**
TOOL BALANCE
- **ADVANCED COOLANT THRU**
BODY DESIGN

REGULAR TYPE - METRIC

TYPE	ORDER NO.	D	L	L ₁	C	C ₁	H	WT. (lb.)	MAX INSERT LENGTH
E40	E40-2003-2	3MM	1.97	.87	.30	.39	.35	0.44	1.65
	E40-2003-3		2.76	1.65		.47		0.44	2.44
	E40-2003-3L		3.35	1.65		.47		0.66	2.72
	E40-2003-4		4.33	2.64		.57		0.66	3.7
	E40-2004-2	4MM	1.97	.87	.39	.48	.47	0.44	1.65
	E40-2004-3		2.76	1.65		.57		0.66	2.44
	E40-2004-3L		3.35	1.65		.57		0.66	2.72
	E40-2004-4		4.33	2.64		.67		0.66	3.7
	E40-2006-2	6MM	1.97	.87	.47	.56	.71	0.44	1.54
	E40-2006-3		2.76	1.65		.65		0.66	2.13
	E40-2006-3L		3.35	1.65		.65		0.66	2.72
	E40-2006-4		4.33	2.64		.75		0.88	3.7
	E40-2008-2	8MM	1.97	.87	.55	.64	.94	0.44	1.54
	E40-2008-3		3.35	1.65		.72		0.66	2.72
	E40-2008-4		3.94	1.65		.72		0.88	3.31
	E40-2010-2	10MM	2.16	.87	.63	.72	1.18	0.66	1.73
	E40-2010-3		3.35	1.65		.80		0.66	2.52
	E40-2010-4		3.94	1.65		.80		0.88	2.52
	E40-2012-2	12MM	2.36	.87	.79	.88	1.18	0.66	1.73
	E40-2012-3	12MM	3.15	1.65	.79	.96	1.18	0.88	2.91
E40-2016-2	16MM	2.36	.87	1.02	1.11	1.26	0.66	1.73	
E40-2020-2	20MM	2.36	1.57	1.26	1.34	1.50	0.88	1.93	

Note: Use with carbide cutting tools only. Coolant Duct is not furnished.

Note: * means carbide cutting tool shank should be inserted beyond the safety mark for optimum accuracy and rigidity.

Note: Require a cutter shank tolerance of h6: Ø1/8" & Ø3MM - Ø5MM and h7: Ø6MM - Ø10MM, per British Standard Limits of Tolerance for selected shafts: BS4500:1969.

MST SLIMLINE SHRINK-FIT HSK 40E SERIES - METRIC, SLIM TYPE

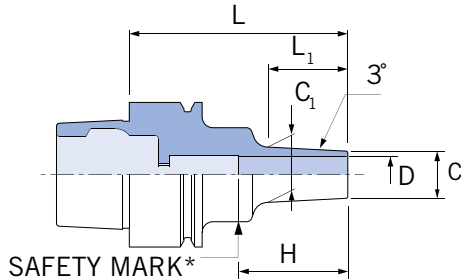

- **GUARANTEED ACCURACIES AT**
Length of 4X DIA.00012" TIR
- **GROUND CHUCK BODY FOR PERFECT**
TOOL BALANCE
- **ADVANCED COOLANT THRU**
BODY DESIGN

SLIM TYPE - METRIC

TYPE	ORDER NO.	D	L	L ₁	C	C ₁	H	WT. (lb.)	MAX INSERT LENGTH
E40	E40-3003-2	3MM	1.97	.87	.24	.33	.35	0.44	1.65
	E40-3003-3		2.76	1.65		.41		0.44	2.44
	E40-3003-3L		3.35	1.65		.41		0.66	2.72
	E40-3003-4		4.33	2.64		.51		0.66	3.7
	E40-3299-2	1/8"	1.97	.87	.24	.33	.35	0.44	1.65
	E40-3004-2	4MM	1.97	.87	.28	.37	.47	0.44	1.65
	E40-3004-3		2.76	1.65		.45		0.44	2.44
	E40-3004-3L		3.35	1.65		.45		0.66	2.72
	E40-3004-4		4.33	2.64		.55		0.66	3.9
	E40-3006-2	6MM	1.97	.87	.35	.44	.71	0.44	1.54
	E40-3006-3		2.76	1.65		.53		0.44	2.13
	E40-3006-3L		3.35	1.65		.53		0.66	2.72
	E40-3006-4		4.33	2.64		.63		0.66	3.7
	E40-3008-2	8MM	2.36	.87	.43	.52	.94	0.66	1.93
	E40-3008-3		3.15	1.65		.61			2.52
	E40-3008-4		3.94	1.65		.61			3.31
E40-3010-2	10MM	2.36	.87	.51	.60	1.18	0.66	1.93	
E40-3010-3		3.15	1.65		.69			2.52	
E40-3010-4		3.94	1.65		.69			3.5	

Note: Use with carbide cutting tools only. Coolant Duct is not furnished.

Note: * means carbide cutting tool shank should be inserted beyond the safety mark for optimum accuracy and rigidity.

Note: Require a cutter shank tolerance of h6: Ø3MM - Ø5MM and h7: Ø6MM - Ø20MM, per British Standard Limits of Tolerance for selected shafts: BS4500:1969.

MST SLIMLINE SHRINK-FIT HSK 50E SERIES - METRIC, REGULAR TYPE

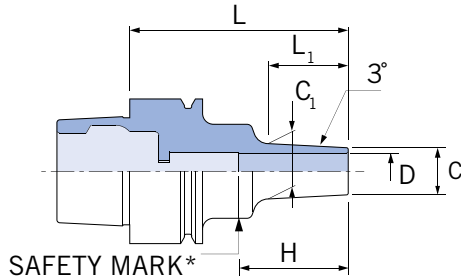

- **GUARANTEED ACCURACIES AT**
Length of 4X DIA.00012" TIR
- **GROUND CHUCK BODY FOR PERFECT**
TOOL BALANCE
- **ADVANCED COOLANT THRU**
BODY DESIGN

REGULAR TYPE - METRIC

TYPE	ORDER NO.	D	L	L ₁	C	C ₁	H	WT. (lb.)	MAX INSERT LENGTH
E50	E50-2003-3	3MM	2.95	.87	.30	.39	.35	1.1	2.56
	E50-2003-4		3.74	1.65		.47		1.1	3.35
	E50-2003-5		4.72	2.64		.57		1.32	4.33
	E50-2003-6		5.91	3.82		.70		1.1	5.20
	E50-2004-3	4MM	2.95	.87	.40	.48	.47	1.1	2.56
	E50-2004-4		3.74	1.65		.57		1.1	3.35
	E50-2004-5		4.72	2.64		.67		1.32	4.33
	E50-2004-6		5.91	3.82		.80		1.54	5.20
	E50-2006-2	6MM	2.36	.87	.47	.56	.71	1.1	1.73
	E50-2006-4		3.74	1.65		.65		1.1	3.03
	E50-2006-5		4.72	2.64		.75		1.32	4.02
	E50-2008-2	8MM	2.36	.87	.55	.64	.94	1.1	1.73
	E50-2008-4	8MM	3.74	1.65	.55	.72	.94	1.1	3.03
	E50-2010-2	10MM	2.36	.87	.63	.72	1.18	1.1	1.73
	E50-2012-2	12MM	2.36	.87	.79	.88	1.18	1.1	1.73
	E50-2016-2	16MM	2.36	.87	1.02	1.11	1.26	1.32	1.73
E50-2020-3	20MM	2.56	.87	1.26	1.35	1.50	1.32	1.93	

Note: Use with carbide cutting tools only. Coolant Duct is not furnished.

Note: * means carbide cutting tool shank should be inserted beyond the safety mark for optimum accuracy and rigidity.

Note: Require a cutter shank tolerance of h6: Ø3MM - Ø5MM and h7: Ø6MM - Ø20MM, per British Standard Limits of Tolerance for selected shafts: BS4500:1969.

MST SLIMLINE SHRINK-FIT HSK 50E SERIES - METRIC, SLIM TYPE

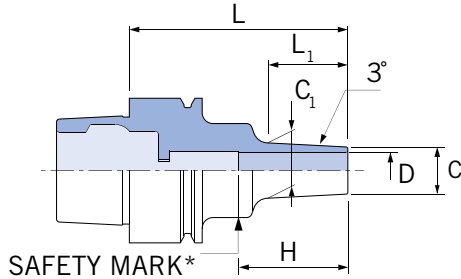

- **GUARANTEED ACCURACIES**
At Length of 4X DIA.00012" TIR
- **GROUND CHUCK BODY FOR PERFECT TOOL BALANCE**
- **ADVANCED COOLANT THRU BODY DESIGN**

TYPE	ORDER NO.	D	L	L ₁	C	C ₁	H	WT. (lb.)	MAX INSERT LENGTH
E50	E50-3003-2	3mm	2.36	.87	.24	.33	.35	0.88	1.97
	E50-3003-3		3.15	1.65		.41		1.1	2.76
	E50-3003-4		3.74	1.65		.41		1.1	3.35
	E50-3004-2	4mm	2.36	.87	.28	.37	.47	0.88	1.97
	E50-3004-3		3.15	1.65		.45		1.1	2.76
	E50-3004-4		3.74	1.65		.45		1.1	3.35
	E50-3006-2	6mm	2.36	.87	.35	.44	.71	1.1	1.65
	E50-3006-3		3.15	1.65		.53		1.1	2.44
	E50-3006-5		4.72	2.64		.63		1.1	4.02
	E50-3006-6		5.91	3.82		.76		1.3	5.2
	E50-3008-2	8mm	2.56	.87	.43	.52	.94	1.1	1.93
	E50-3008-3		3.35	1.65		.61		1.1	2.64
	E50-3008-5		4.72	2.64		.71		1.32	4.02
	E50-3008-6		5.91	3.82		.83		1.54	5.2
	E50-3010-2	10mm	2.56	.87	.51	.60	1.18	0.66	1.93
	E50-3010-3		3.35	1.65		.69		0.66	2.52
	E50-3010-5		4.72	3.82		.79		1.32	2.52
	E50-3010-6		5.91	3.82		.91		1.54	2.52
E50-3012-2	12mm	2.56	.87	.59	.68	1.18	1.1	1.93	
E50-3012-3		3.35	1.65		.76		1.1	2.52	
E50-3012-5		4.72	2.64		.87		1.32	2.52	

Note: Use with carbide cutting tools only. Coolant Duct is not furnished.

Note: *means carbide cutting tool shank should be inserted beyond the safety mark for optimum accuracy and rigidity.

Note: Require a cutter shank tolerance of h6: Ø3MM - Ø5MM and h7: Ø6MM - Ø20MM, per British Standard Limits of Tolerance for selected shafts: BS4500:1969.

MST SLIMLINE - HOT AIR HEATER FOR SHRINK-FIT CHUCKING SYSTEM

HEAT ROBO BABY 3000



Photo shown with optional accessories and Slimline Holder.

- **POWERFUL 3000 WATTS HEATING GUN**
- **AVERAGE HEATING TIME*:**
1-2 MINUTES FOR CUTTER INSERTION
2-3 MINUTES FOR CUTTER REMOVAL
- **STANDARD ACCESSORIES**
 - 1 pair Heat Resistant Gloves
 - 1 ea. Stop Watch
 - 1 ea. Tweezers
 - 1 ea. Nozzle
 - 1 ea. Adjustable Heater Stand, HRB-LSA-01
 - 1 ea. Nozzle Cover, HRB-NGA-01

ORDER NO.	POWER CONSUMPTION	DIMENSIONS (in)	WT. (lb.)
HRB-03S-230	AC230V-3000W	16.7 X 7.9 X 20.3	11

Note: *Heating time varies depending on size of toolholders and cutting tools.
 Note: Optional positioning plate for radial adjustment, HRB-PPA-01, is available upon request.

MST SLIMLINE INDUCTION HEATER FOR SHRINK-FIT CHUCKING SYSTEM

HEAT ROBO DENJI 1200



- **EXCLUSIVELY ENGINEERED FOR SLIMLINE'S SPECIAL MATERIAL**
- **AVERAGE HEATING TIME***
18 SECONDS FOR 3MM-6MM DIA. SHANKS
33 SECONDS FOR 8MM-12MM DIA. SHANKS
- **STANDARD ACCESSORIES**
 - 1 pair Heat Resistant Gloves
 - 1 ea. Tweezers
 - 1 ea. Coil 1 for 3-6mm Dia. Shanks
 - 1 ea. Coil 2 for 8-12mm Dia. Shanks

ORDER NO.	POWER CONSUMPTION	DIMENSIONS (in)	WEIGHT (lb.)
HRD-01	AC100V-1200W	9.9 X 15.4 X 21.3	31

MST'S OTHER FINE PRODUCTS - MONO AND MONO CURVE SERIES

MONO



- **GUARANTEED ACCURACIES..... .00012" TIR**
- **ADVANCED COOLANT THRU BODY DESIGN**
- **OPTIMUM RIGIDITY**
- **IDEAL FOR 5 AXIS MACHINING AND DEEP CAVITY APPLICATION WITH MONO CURVE**
- **CONSISTS OF TWO TYPES OF SPECIAL ALLOY STEEL THAT HAVE BEEN LASER-WELDED TOGETHER. THUS, THE TOOL DESIGN PROVIDES SUPERB ACCURACY AND OPTIMUM RIGIDITY FOR MANY YEARS TO COME.**
- **MONO & MONO CURVE AVAILABLE IN CAT50, HSK32E, HSK40E HSK50E, HSK63A, AND HSK100A**

MONO CURVE

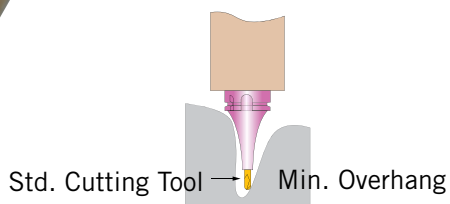

MST SLIMLINE SHRINK-FIT CHUCKING SYSTEM - ACCESSORIES

STOPPERS (STANDARD TYPE)



ORDER NO.	SHANK DIA.	ORDER NO.	SHANK DIA.
HSA-1/8	1/8"	HSA-3	3MM
HSA-3/16	3/16"	HSA-4	4MM
HSA-1/4	1/4"	HSA-6	6MM
HSA-3/8	3/8"	HSA-8	8MM
HSA-1/2	1/2"	HSA-10	10MM
		HSA-12	12MM
		HSA-16	16MM
		HSA-20	20MM

STOPPERS (G TYPE)



Note: D means shank diameter.

ORDER NO.	D	ORDER NO.	D
HSB-1/8	1/8"	HSB-3	3MM
HSB-3/16	3/16"	HSB-4	4MM
HSB-1/4	1/4"	HSB-6	6MM
HSB-5/16	5/16"	HSB-8	8MM
HSB-3/8	3/8"	HSB-10	10MM
HSB-1/2	1/2"	HSB-12	12MM
HSB-5/8	5/8"	HSB-16	16MM
HSB-3/4	3/4"	HSB-20	20MM
HSB-1	1"	HSB-25	25MM

TAPER POT ADAPTERS



BAA-01

ORDER NO.	SHANKS
ADH-HSK25	E25
ADH-HSK32	E32
ADH-HSK40	A40/E40
ADH-HSK50	E50/F63
ADH-40	BT40/CT40/A63
ADH-50	CT50
ADH-SLK	SLIMLINE ADAPTER
BAA-01*	POT BASE/A100

Note: ADH-SLK is used with Slimline Adapters.

Note: *means BAA-01 can be used as a base or as an adapter pot as shown.

Note: All ADH adapters need to be mounted on BAA-01 for use.

WRENCH FOR TWO-PIECE SLIMLINE, DETa-1, & CTA-CTH COLLET CHUCKS

FIG. 1

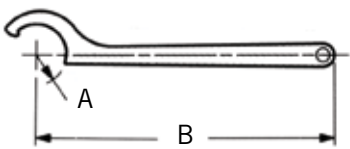

FIG. 2

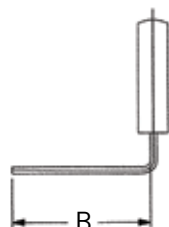
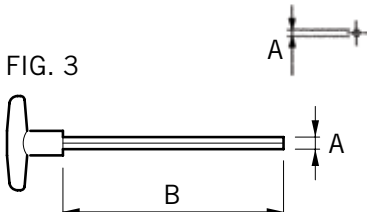

FIG. 3



CHUCK SIZE	ORDER NO.	A	B	FIG.
A070 (DETa-1)	10070	.75	7.05	1
A120 (DETa-1)	10120	.89	8.86	
#113 (CTA/CTH)	10113	.71	8.20	
#116 (CTA/CTH)	10116	.98	11.10	
#118 (CTA/CTH)	10118	1.22	12.30	
SLIMLINE MASTER E070, E120 (DETa-1)	W-135	5mm	4.33	2
B070 (DETa-1)	TW-5	5mm	6.02	3
B120 (DETa-1)	TW-6	6mm	7.88	3

ASK ABOUT MST'S RITE ANGLE HEAD PRODUCTS!



Visit Us At www.kitagawa-usa.com or Call 1.800.222.4138 To Learn More About All Our Workholding & Tooling Solutions!



Headquarters, manufacturing and service for the Americas, Kitagawa NorthTech, Inc. is located in Schaumburg, IL.

Distributed by: